

1

@YOYIPONS

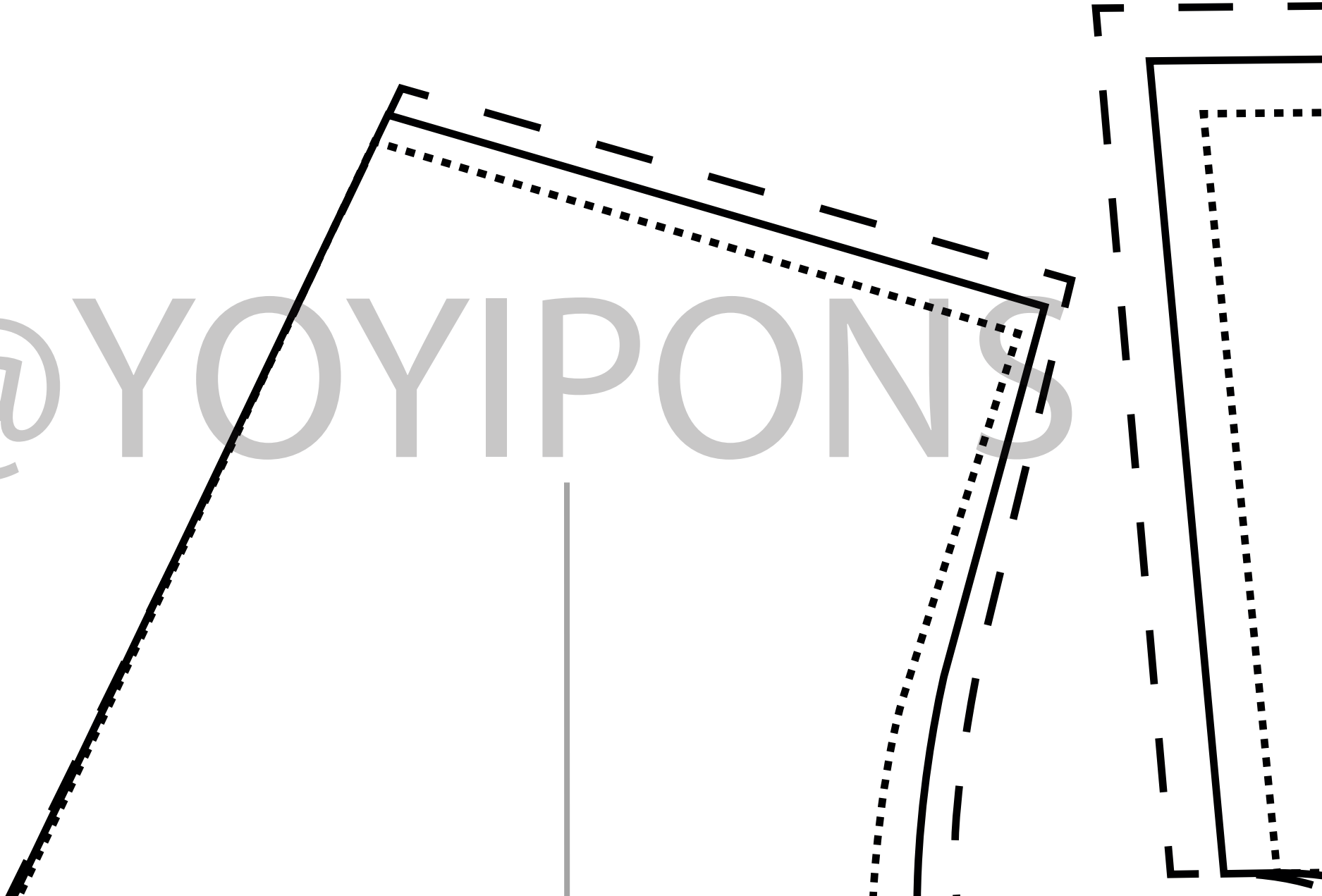

2

@YOYIPONS

T-W-S

X1

VIS. ESP. VESTIDO OP

3

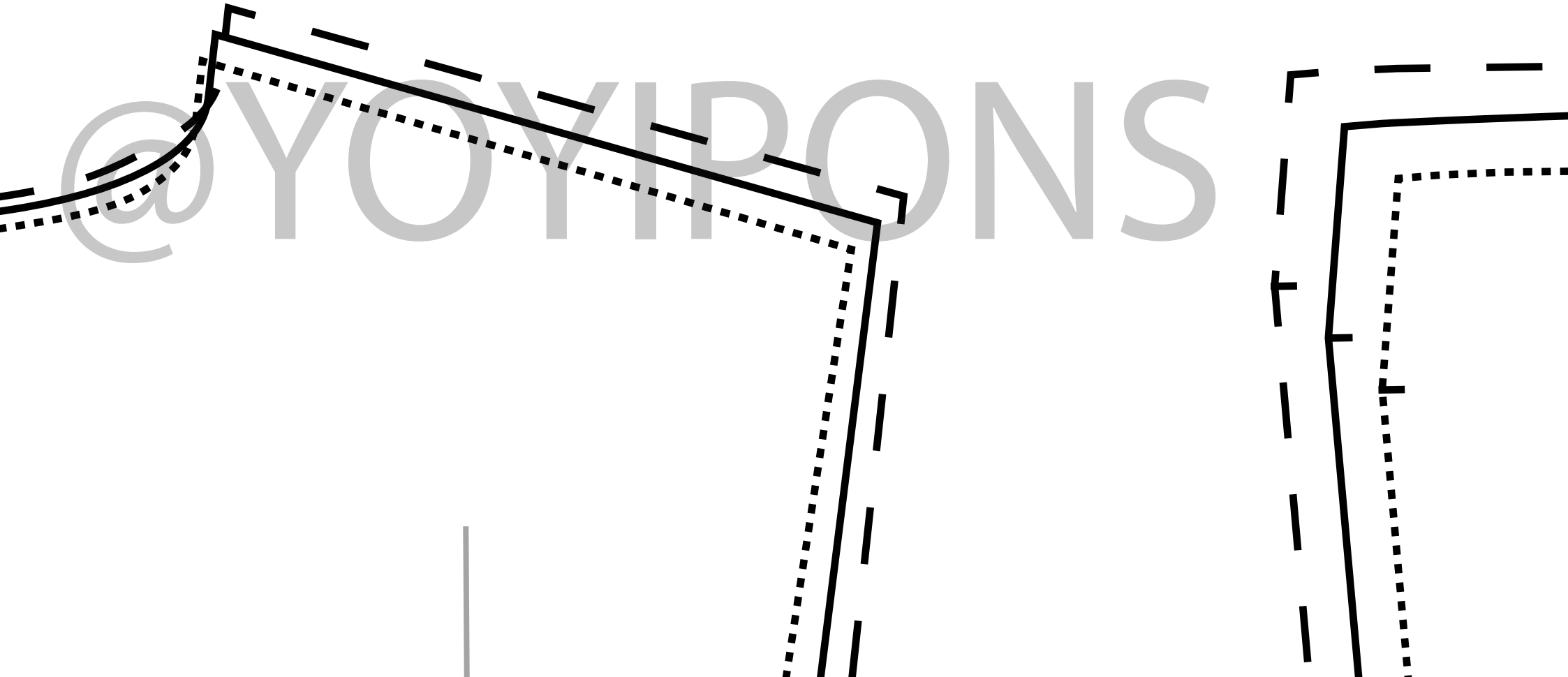

4

@YOYIPONS

5

VIS. DEL. VESTIDO OP

X1

S-M-L

@YOYIPONS

VIS FCB/STINDO OP

6

@YOYIPONS

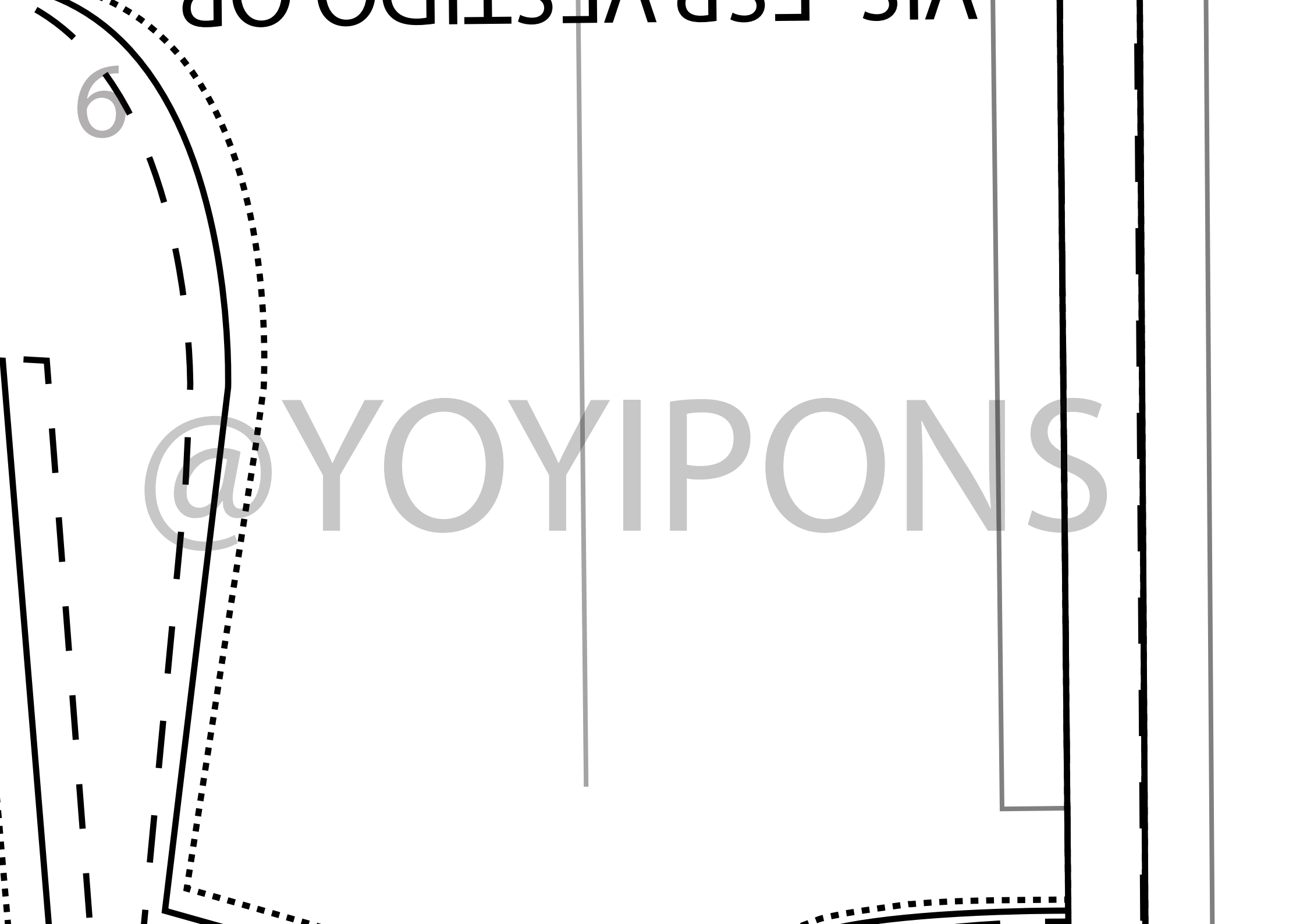

7

@YOYIPONS

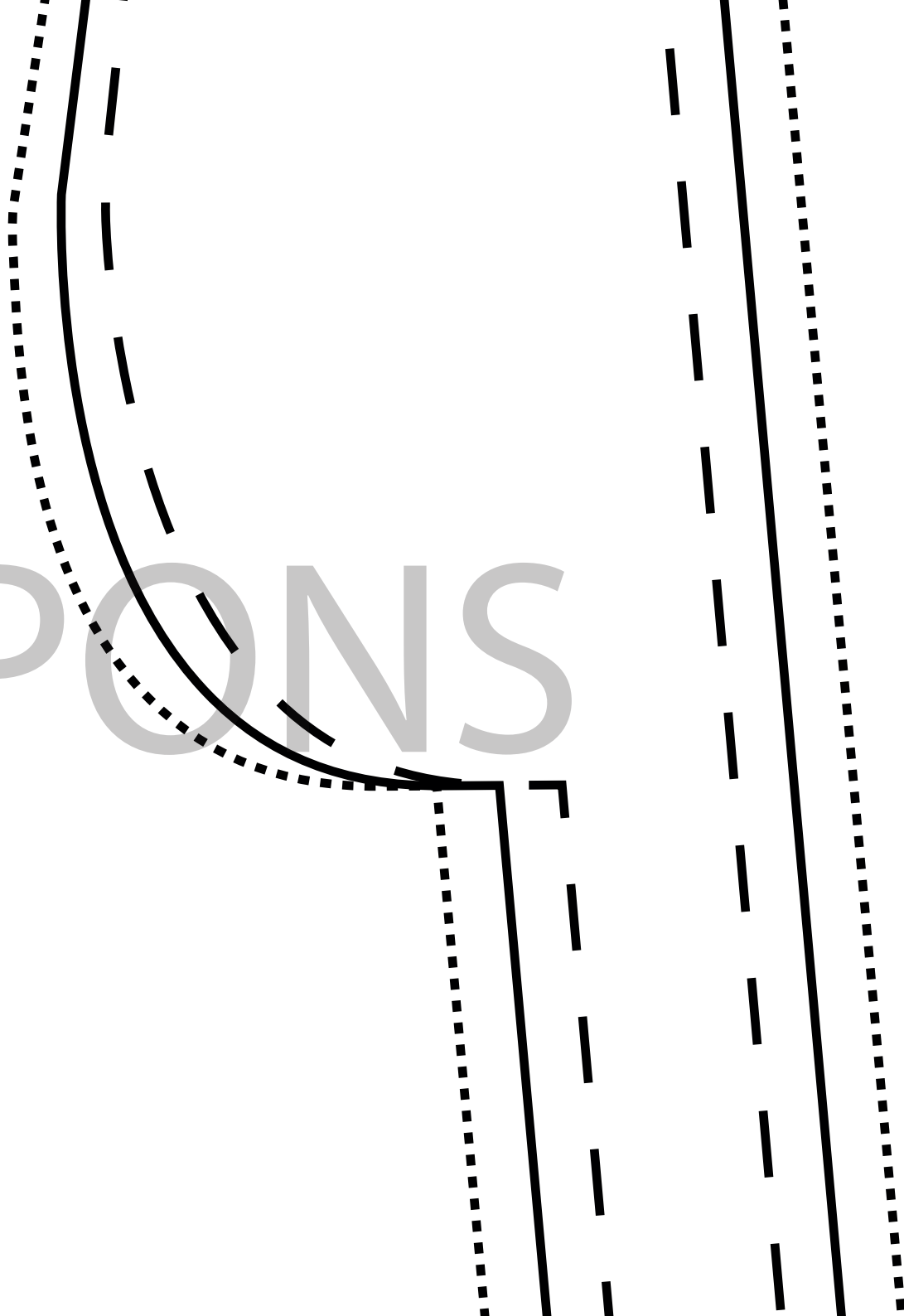

8

@YOYIPONS



1

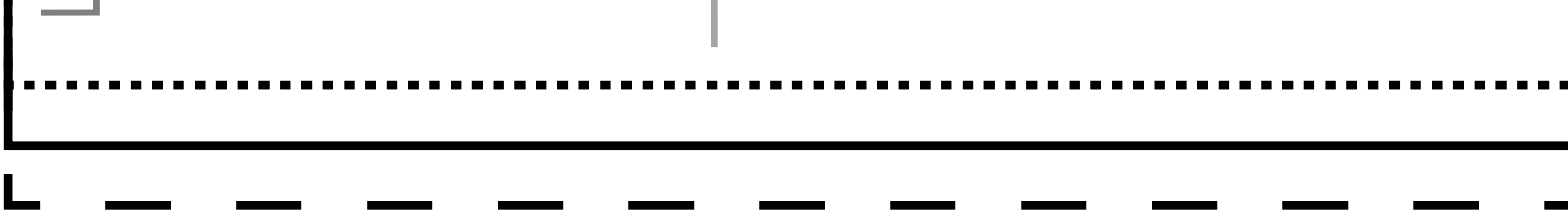

@YOYIPONS

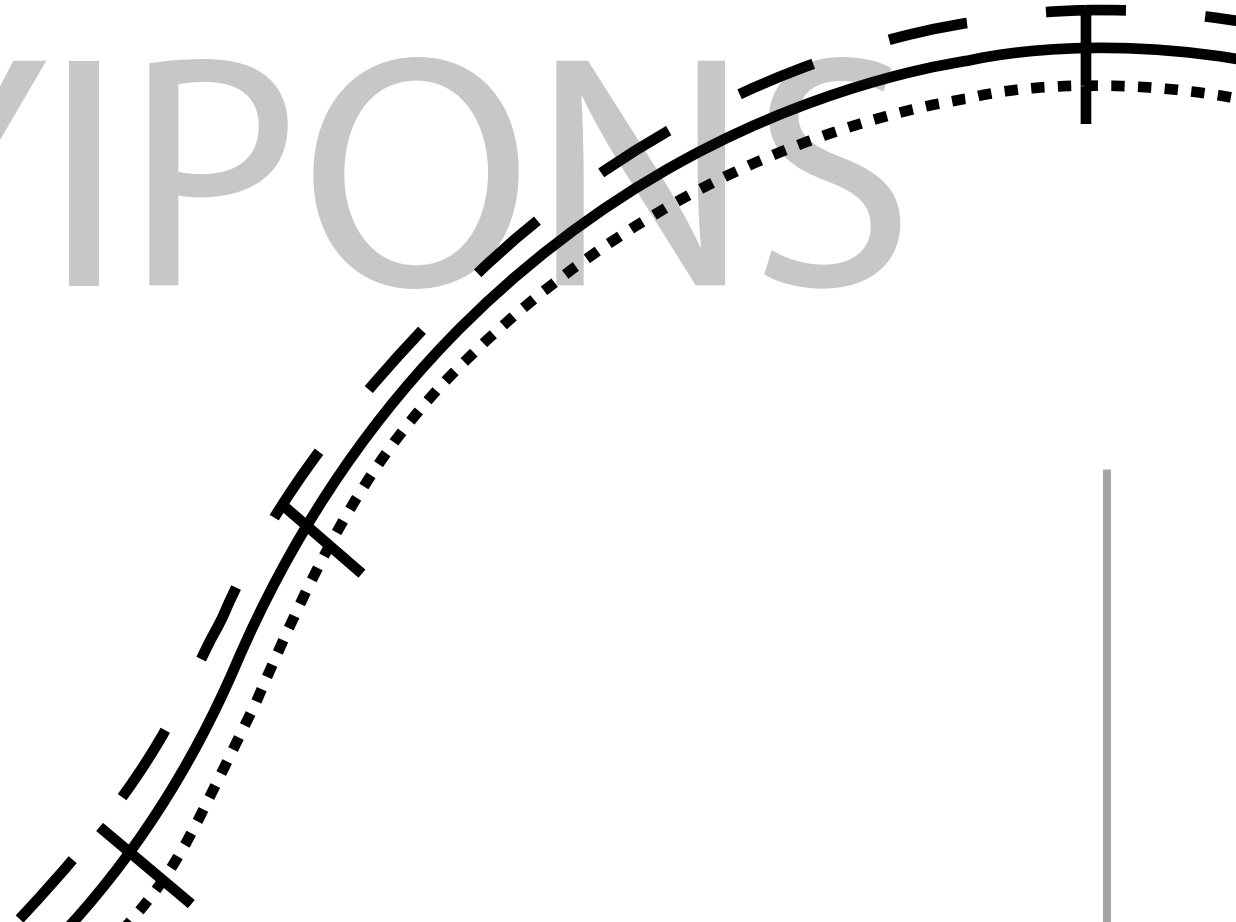

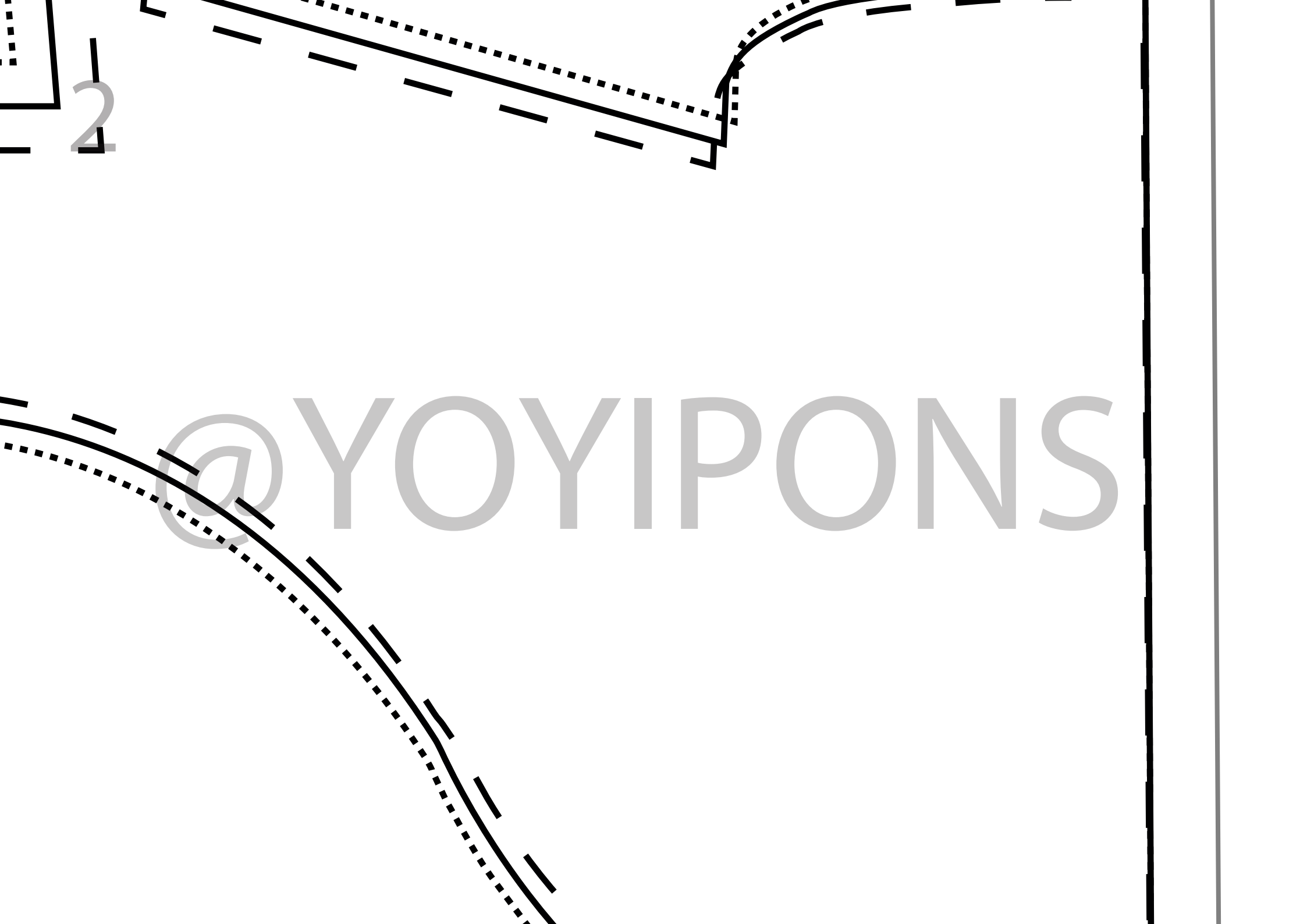

2

@YOYIPONS

3  
ESP. VESTIDO OP

X1

S-M-L

@YOYIPONS

4

@YOYIPONS

T-W-S

LX

9

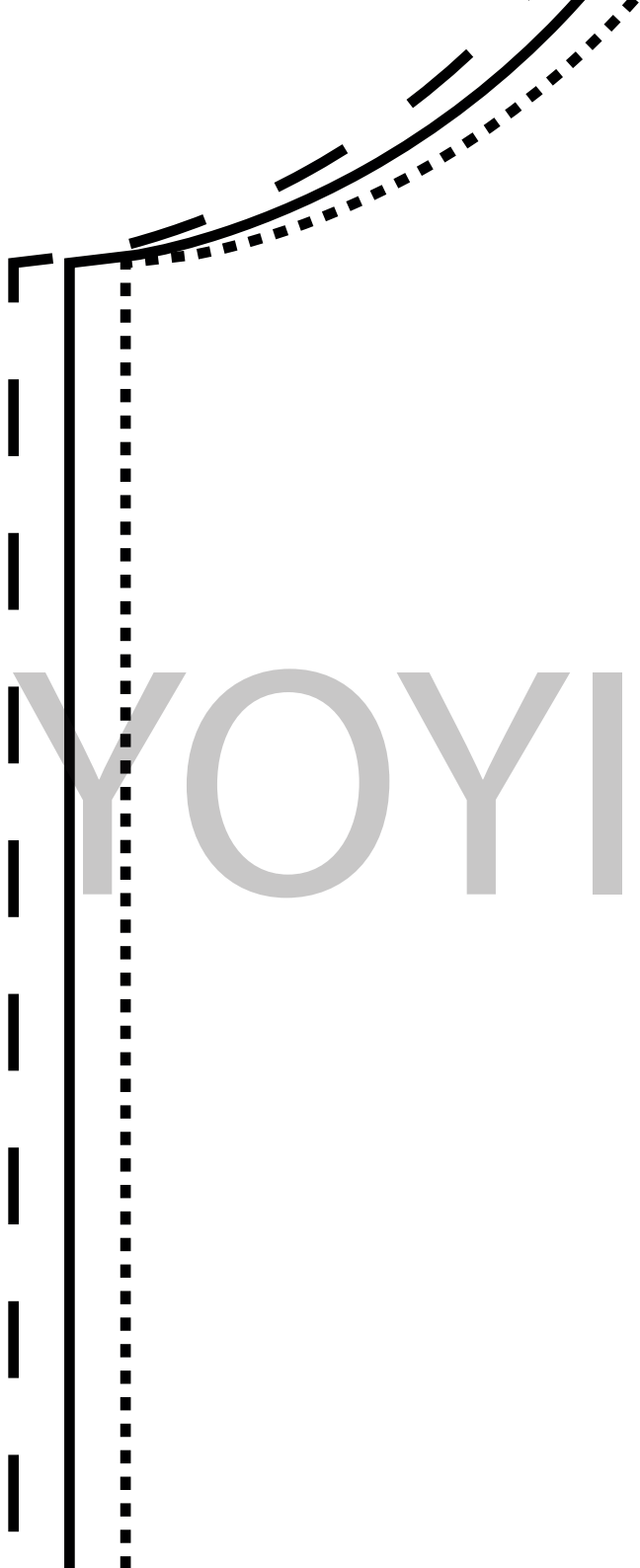

MAN. VEST

X2

@YOYIPONS S-M-

10

DO OP

L

@YOYIPONS

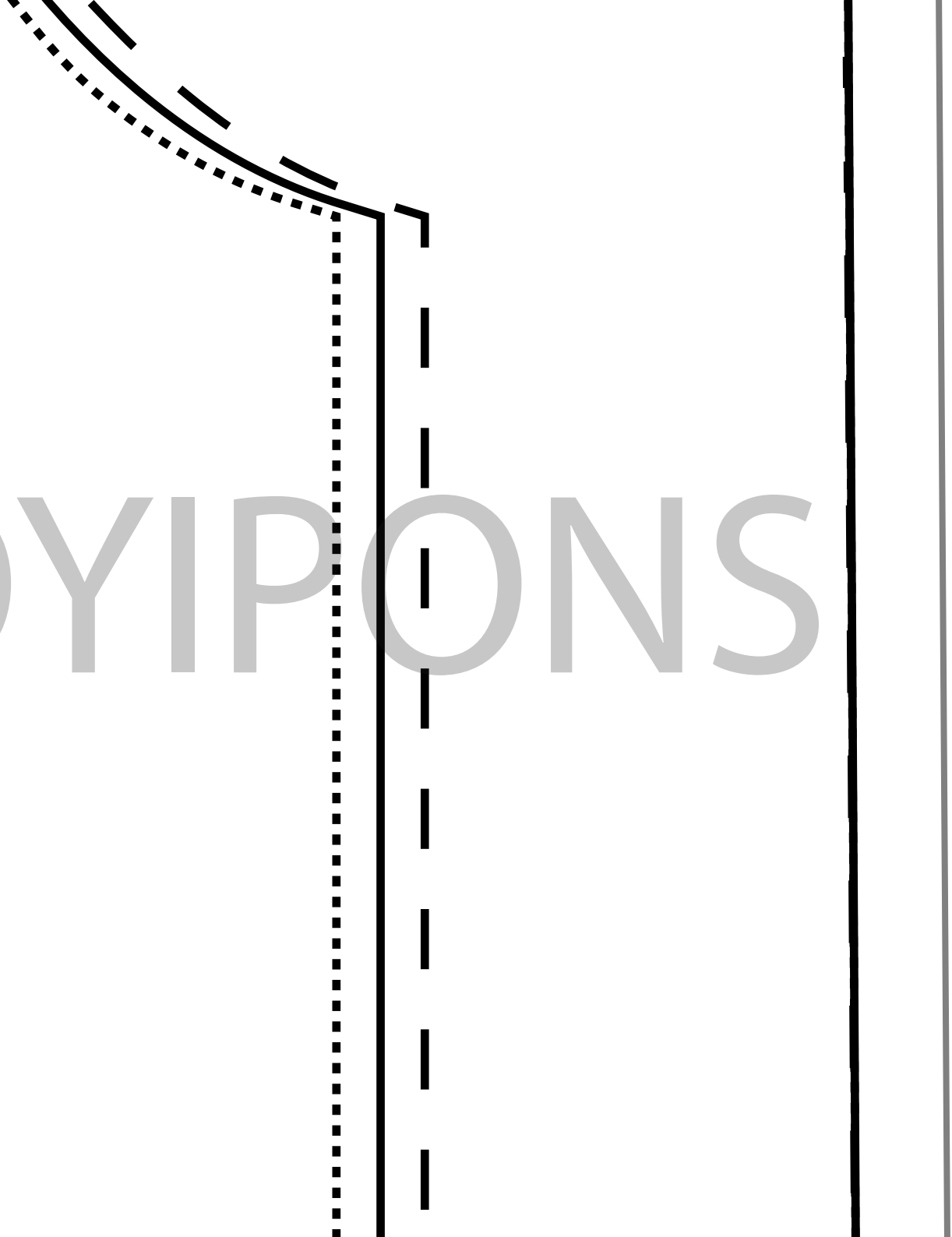

11

@YOYIPONS

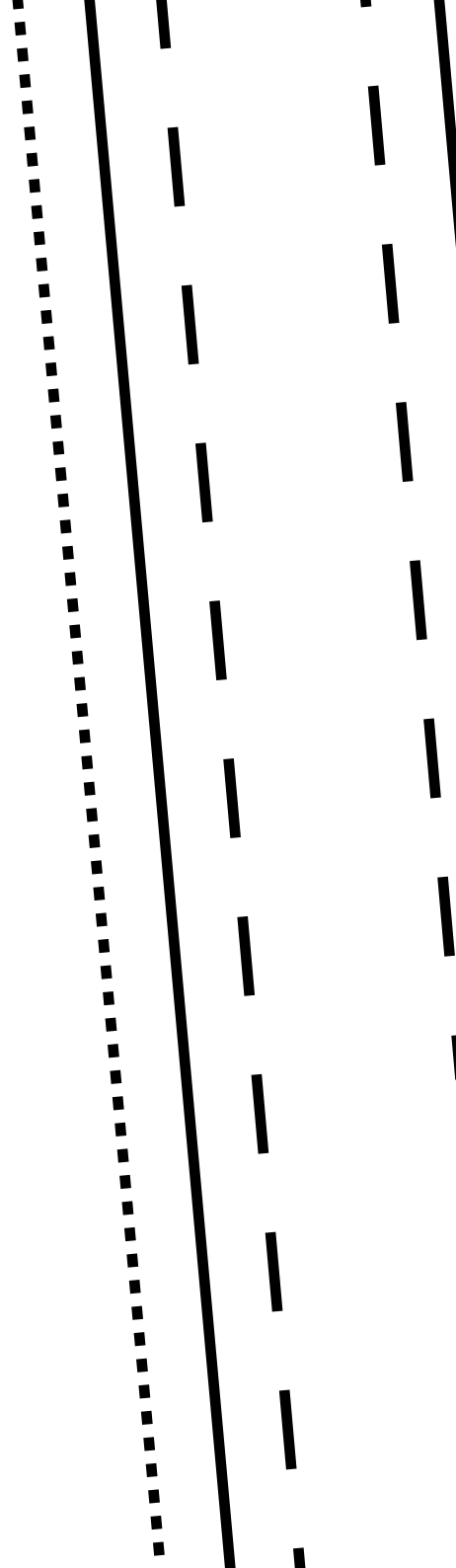

DEL. VESTIDO OP

12

@YOYIPONS



15

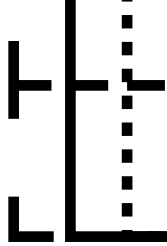

@YOYIPONS

COMPRO

MED

15

16

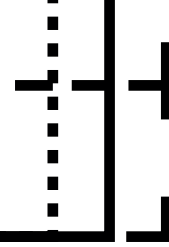

BACI3N DE  
DIDAS

X15

@YOYIPONS

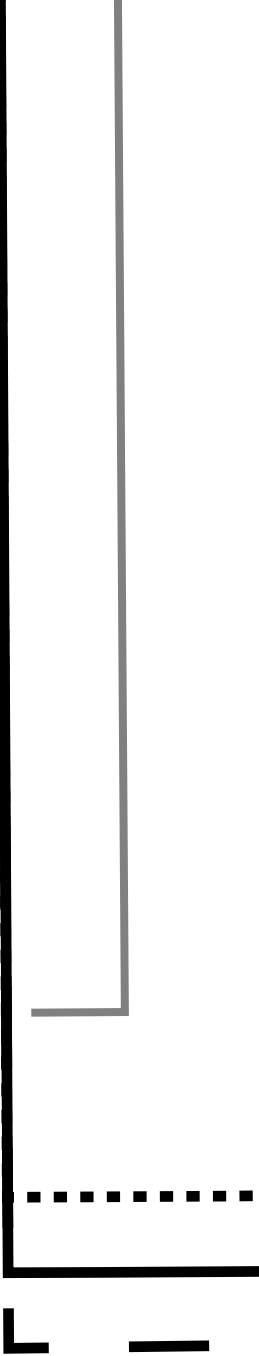

17

@YOYIPONS

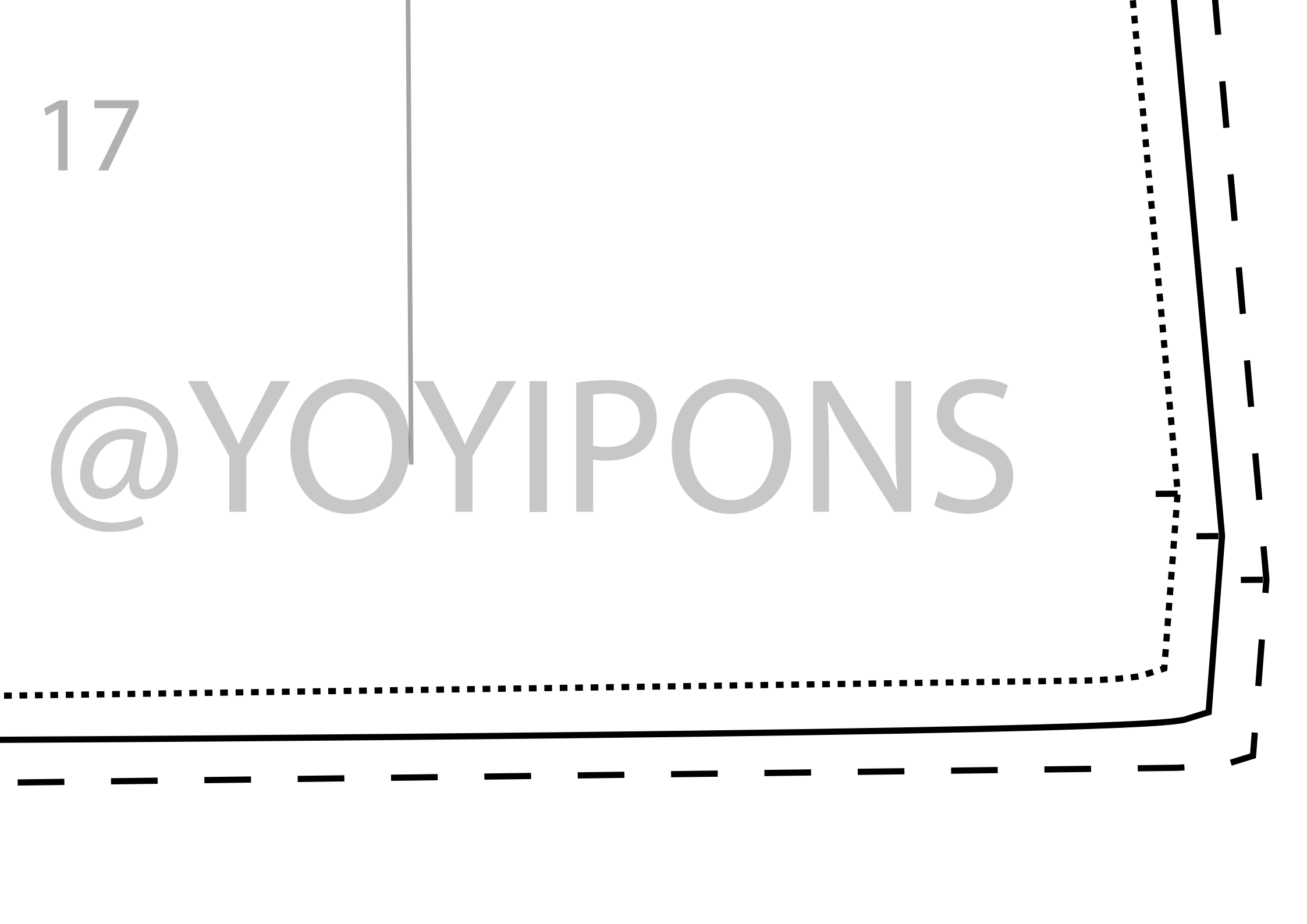

18

@YOYOYIPONS

